

# Versamet 19"



## Versamet 19" Rack Cases

Modern and versatile 19" rack cases with anodised aluminium front panel and integrated 'comfort-handles'. Folded aluminium case body with all fixings hidden on the underside. Removable base and rear panel for easy access.

## Versamet 19" Rack-Gehäuse

Modern und vielseitig einsetzbare 19" Rack-Gehäuse mit eloxierter Aluminium-Frontplatte und integrierten 'Komfortgriffen'. Gehäuse aus Aluminium, gekantet. Alle Befestigungen auf der Unterseite. Abnehmbare Boden- und Rückplatte für guten Zugang.

## Boîtier Versamet pour rack 19"

Des boîtiers 19" rack modernes et polyvalents avec plaque avant anodisée et poignées de confort intégrées. Corps de boîtiers en aluminium plié avec toutes les fixations cachées au-dessous. Plaque inférieure et arrière amovible pour l'accès facile.

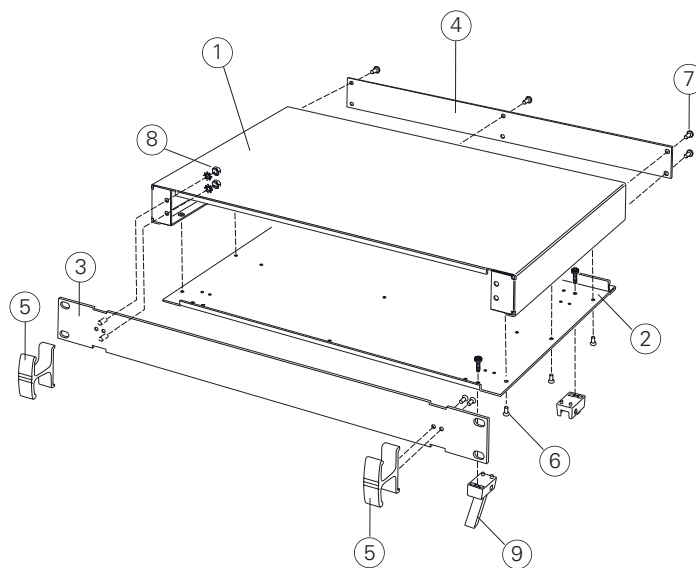

### Supply

- ① Top cover
- ② Base panel
- ③ 19" front panel
- ④ Rear panel
- ⑤ Handles
- ⑥ M3 x 8 mm (x6)
- ⑦ M3 x 8 mm (x4/6)
- ⑧ M4 nut & washer (x4)
- ⑨ \*ABS feet  
\* Accessories

### Lieferumfang

- Deckplatte
- Bodenplatte
- 19" Frontrahmen
- Rückplatte
- Griffe
- M3 x 8 mm (x6)
- M3 x 8 mm (x4/6)
- M4 Mutter & Unterlegscheibe (x4)
- \*Gehäusefüße (ABS)
- \* Zubehör

### Fourniture

- Partie supérieure
- Plaque inférieure
- Plaque avant 19"
- Plaque arrière
- Poignées
- M3 x 8 mm (x4)
- M3 x 8 mm (x4/6)
- Écrou & rondelle de joint M4 (x4)
- \*Pieds du boîtier (ABS)
- \* Accessoires

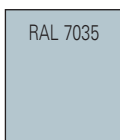

Standard colours  
Standardfarben  
Coloris standard

## Versamet 19"

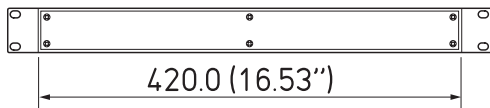
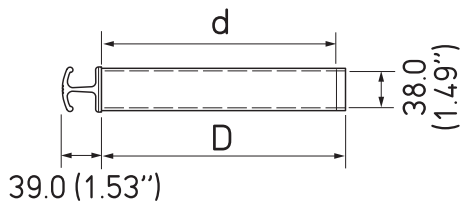
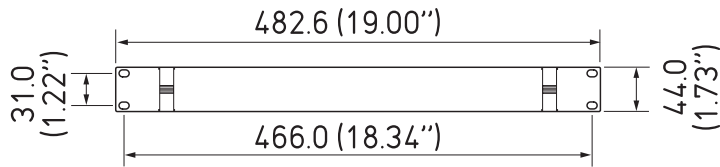

1U (1HE) x 165 mm



1U (1HE) x 165 mm



1U (1HE) x 265 mm

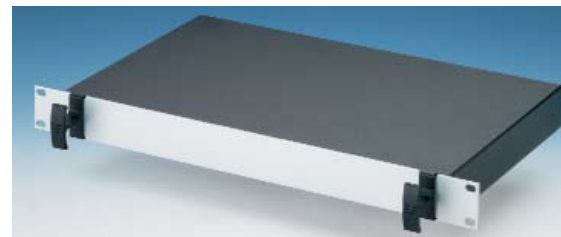

1U (1HE) x 265 mm

Part No. Bestell-Nr./Réf.	H	D	d	Colours Farben/Coloris
<b>M 49 19 115</b>	1U (1HE)	165 (6.49")	153 (6.02")	● RAL 7035
<b>M 49 19 119</b>	1U (1HE)	165 (6.49")	153 (6.02")	● RAL 9005
<b>M 49 19 125</b>	1U (1HE)	265 (10.43")	253 (9.96")	● RAL 7035
<b>M 49 19 129</b>	1U (1HE)	265 (10.43")	253 (9.96")	● RAL 9005

## ABS Case Feet

Gehäusefüße (ABS)  
Pieds du Boîtier (ABS)

Part No. Bestell-Nr./Réf.	Article Artikel	Colours Farben/Coloris
<b>M 56 00 015</b>	① + ② x 4	● RAL 7035
<b>M 56 00 019</b>	① + ② x 4	● RAL 9005
<b>M 56 00 045</b>	① + ② x 4 + ③ x 2	● RAL 7035
<b>M 56 00 049</b>	① + ② x 4 + ③ x 2	● RAL 9005

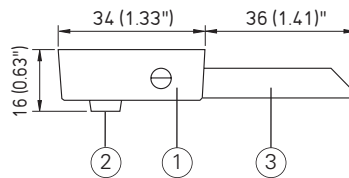

## 19" Mounting Kit

19"-Montage-Set  
Kit de Montage Pour Châssis 19"

Part No. Bestell-Nr./Réf.	Article Artikel	Colours Farben/Coloris
<b>M 60 00 035</b>	① + ② + ③ x 4	● RAL 7035 ②
<b>M 59 00 016</b>	① + ② + ③ x 4	● RAL 9005 ②

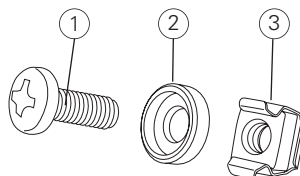

## PCB Mounting Kit

Leiterkarten Montage-Set  
Jeu Pour Montage Des Circuits Imprimés

Part No. Bestell-Nr./Réf.	Article Artikel
<b>M 56 00 001</b>	① + ② x 10

